

ESCO
SCIENTIFIC



VIVA® G4

Class II Type A2 Animal BSC

The Portable Safety Solution for Animal Research Laboratories



VIVA® G4 (VA2 G4) CLASS II TYPE A2 ANIMAL BSC,

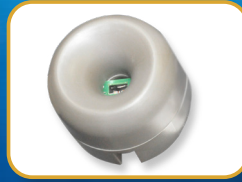

Airflow Sensor

- Monitors real-time airflow for safety
- Alerts the user if airflow is insufficient

USB Port and Zero Volt Relay Contact

- USB Port to send operational information to Building Management System (BMS)
- Zero Volt Relay Contact to turn ON/OFF exhaust blower and signal the building alarm



Centurion 7" Capacitive Touchscreen Controller

- Displays all safety information on one large screen
- Shows cabinet parameters with intuitive 3D illustration
- Easy to use menu, similar to Smart Phone Apps
- Large buttons, easy to operate when wearing gloves
- Self-guidance to users to deal with specific situations
- Centered and angled down for easy reach and viewing

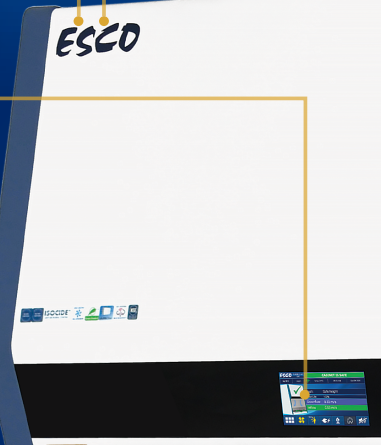

Single Piece Wall

- Easy to reach service fixtures and electrical outlets on sidewalls
- Large radius corners for easy cleaning



User-friendly Work Tray

- Largest useable area in the market
- Recessed to contain spillage
- Sloped perimeter for easy cleaning
- Large, easy to clean tray handle



Raised Arm Rest

- Prevent grille blocking
- Comfortable working posture
- Durable stainless steel construction



Ergonomic Work Zone

- 10° angle to optimize user comfort, reduce glare, and maximize reach into the work area
- Brightly illuminated with 1000 lux (93 ft-c)
- Industry-leading dimmable LED for optimum work comfort
- Airtight seal port for cable/tube exit protected by a negative pressure side wall
- 12" sash working height for mouse and rat cages

Available in 1.2, 1.5, and 1.8 meter models (4', 5', and 6').



Pre-filter Rack

- Captures animal dander
- Easy to replace pre-filter
- Prolongs ULPA filter life



FEATURING ADVANCED TOUCHSCREEN CONTROLLER

Energy-efficient DC ECM Blower

- The leading energy-efficient Class II Type A2 Biosafety Cabinet in the world with 70% energy savings compared to AC motor
- Stable airflow despite building voltage fluctuations and filter loading
- Standby mode to further reduce power consumption by 80%

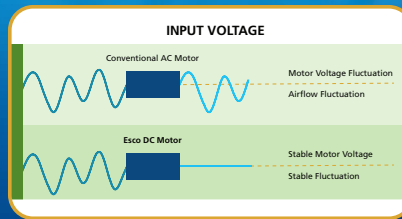

Advanced ULPA Filtration System

- 10x Filtration efficiency of HEPA filter
- Creates ISO Class 3 work zone instead of industry-standard ISO Class 5
- Same 10 years filter life and replacement cost as HEPA filters

Note:

- 99.999% at 0.1 to 0.3 micron, ULPA as per IEST-RP-CC001.3 USA
- 99.999% at MPPS, H14 as per EN 1822 EU



Dimmable LED Lamp

- Save energy and optimize work comfort



Removable Paper Catch

- Prevent objects from being pulled into blower plenum
- Removable for easy cleaning



Tray Support Beams

- Support work tray evenly for less vibration
- Cleaning holder to easily wipe the drain pan

Isocide™ Powder Coat

- Silver-ion impregnated powder coat
- Inhibits microbial growth to improve safety
- Prevents the plenum from becoming biohazard landfill

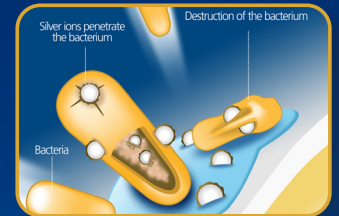

ELISA Proven Containment

- Provides >99% allergen containment.
- Ensures user's safety



Certification

	Performance	Air Quality	Filtration	Electrical Safety
Standards Compliance	NSF / ANSI 49, USA*	ISO 14644.1, Class 3, Worldwide US Fed Std 209E, Class 1 USA JIS B9920, Class 3, Japan	EN-1822 (H14), Europe IEST-RP-CC001, USA	UL 61010-1 3rd Ed, USA CSA22.2, No.1010-192, Canada IEC61010-1, Worldwide

* The NSF / ANSI 49 certified models are VA2-4S_ G4 and VA2-6S_ G4

Dynamic Chamber™

- Blower plenum and side walls are surrounded by negative pressure
- Prevent contaminants from escaping outside

- Positive Pressure
- Negative Pressure



General Specifications, VIVA® Class II Type A2 Animal BSC

Model	220-240 V 50/60Hz	VA2-4S8 G4 12" 2011861	VA2-5S8 G4 12"* 2011863	VA2-6S8 G4 12" 2011865
	110 - 120 V 50/60Hz	VA2-4S9 G4 12" 2011862	VA2-5S9 G4 12"* 2011864	VA2-6S9 G4 12" 2011866
Nominal Size	1.2 meter (4')		1.5 meter (5')	
External dimensions with SLC support stand at minimum height (W x D x H)**	1485 x 919 x 2025-2533 mm (58.5" x 36.2" x 79.7-99.7")		1790 x 919 x 2025-2533 mm (70.4" x 36.2" x 79.7-99.7")	
Internal work area, dimensions (W x D x H)	1220 x 625 x 720 mm (48.0" x 24.6" x 28.3")		1525 x 625 x 720 mm (60.0" x 24.6" x 28.3")	
Maximum sash opening	575 mm (22.6")			
Average airflow velocity	Inflow	0.53 m/s (105 fpm)		
	Downflow	0.30 m/s (60 fpm)	0.35 m/s (70 fpm)	0.35 m/s (70 fpm)
Airflow volume	Inflow / exhaust without ducting	710 m³/h (420 cfm)	890 m³/h (525 cfm)	1065 m³/h (630 cfm)
	Downflow	771 m³/h (461 cfm)	1128 m³/h (662 cfm)	1349 m³/h (794 cfm)
	Required exhaust with optional thimble exhaust collar	1070 m³/h (630 cfm)	1340 m³/h (790 cfm)	1610 m³/h (950 cfm)
ULPA Filter typical efficiency	>99.999% at 0.1 to 0.3 micron, ULPA as per IEST-RP-CC001.3 USA >99.999% at MPPS, H14 as per EN 1822 EU			
Sound emission per NSF / ANSI 49***	60 dBA		65 dBA	65.9 dBA
LED Lamp intensity	1000 lux (93 foot-candles)			
Cabinet construction	Main body	Electro-galvanized steel with white oven-baked epoxy-polyester Isocide™ antimicrobial powder-coated finish, 1.5 mm (0.06") / 16 gauge thick		
	Workzone	Stainless steel type 304 with no.4 finish, 1.5 mm (0.06") / 16 gauge thick		
Net weight cabinet including stand	287 kg (633 lbs)		381 kg (840 lbs)	400 kg (882 lbs)
Shipping weight Cabinet including stand	350 kg (772 lbs)		439 kg (968 lbs)	506 kg (1116 lbs)
Shipping dimensions, maximum (W x D x H) cabinet excluding stand	1400 x 950 x 2250 mm (55.1" x 37.4" x 88.6")		1650 x 950 x 2250 mm (64.9" x 35.0" x 74.8")	
Shipping volume, excluding stand	2.5 m³ (cu.ft.)		3.00 m³ (cu.ft.)	

*Only VA2-4S_ G4 12" and VA2-6S_ G4 12" are the NSF-certified models.

**Depth with arm rest removed: 815 mm (32.1") without SLC stand and 852mm (33.5") with SLC stand

***Noise as measured in open field / anechoic chamber. Noise reading in normal room varies by room size, layout, and background noise, but may reach roughly 3-4 dBA above these values.

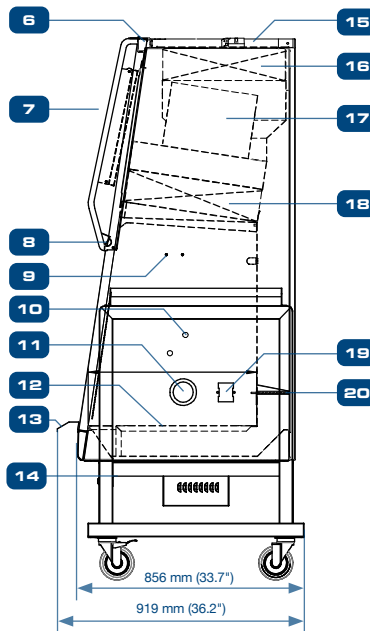
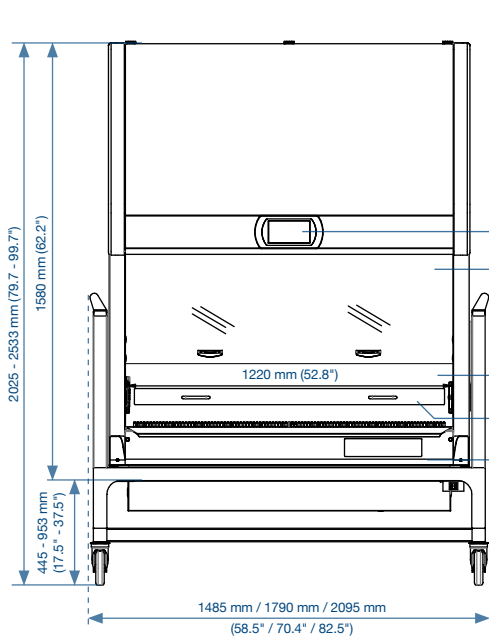

1. Centurion™ Touchscreen Controller
2. Safety Glass Sliding Sash Window
3. Single-piece Stainless Steel Back Wall and Side Walls
4. Prefilter Rack
5. Removable Side Panel for Plumbing Access
6. USB Port for Data Transfer Data, Zero Volt Relay Contact (Blower & Alarm)
7. Electrical Panel
8. LED Lamps
9. IV Bar Retrofit Kit Provision
10. Plugged Service Fixture provisions (2 on each side)
11. Cable Port
12. Stainless Steel Single-piece Work Tray
13. Stainless Steel Arm Rest
14. Drain Valve Retrofit Kit Provision
15. Airflow Sensor
16. Exhaust ULPA / H14 Filter
17. Energy-efficient DC ECM Blower
18. Downflow ULPA / H14 Filter
19. Pre-filter
20. GFCI Electrical Outlet (5A Max)

Common Accessories



Additional SF-2U Service Fixture

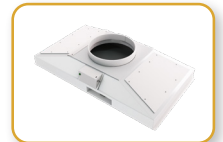

Thimble Exhaust Collar with Alarm



STA Stand



SLC Motorized Stand, 18-30" or 18-38" height

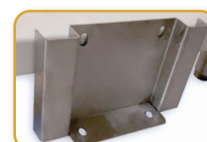

Seismic Bracket



Foot Rest

ESCO

LIFESCIENCES GROUP

Esco Lifesciences Group Offices: Bangladesh | China | Denmark | Germany | Hong Kong | India | Indonesia | Italy | Japan | Lithuania | Malaysia | Myanmar | Philippines | Russia | Singapore | South Africa | South Korea | Taiwan | Thailand | UAE | UK | USA | Vietnam

Esco Micro Pte. Ltd.
19 Changi South Street 1 • Singapore 486779
Tel +65 6542 0833 • mail@escolifesciences.com
www.escolifesciences.com

Esco Technologies, Inc.
903 Sheehy Drive, Suite F, Horsham, PA 19044, USA
Tel: +1 215-441-9661 • eti.admin@escolifesciences.com

9010634_VIVA-VA2-Gen4-A4_v8_031824

Esco can accept no responsibility for possible errors in catalogues, brochures and other printed materials. Esco reserves the right to alter its products and specifications without notice. All trademarks and logos in this material are the property of Esco and the respective companies.